

CSW SERIES – DIMENSIONS

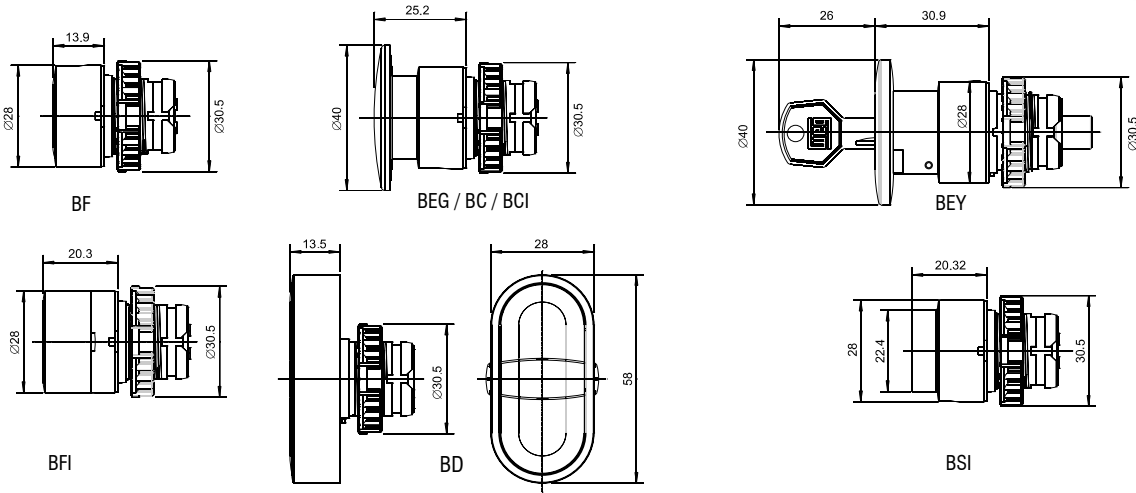

PUSHBUTTONS



PILOT LIGHTS

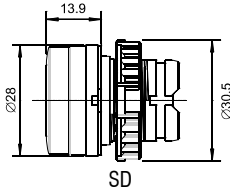

LED AND LAMP BLOCKS

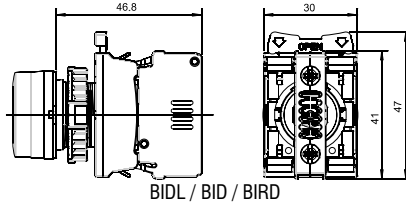

DRILLING

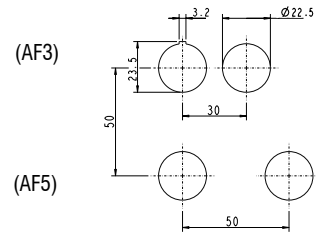

SELECTOR SWITCHES

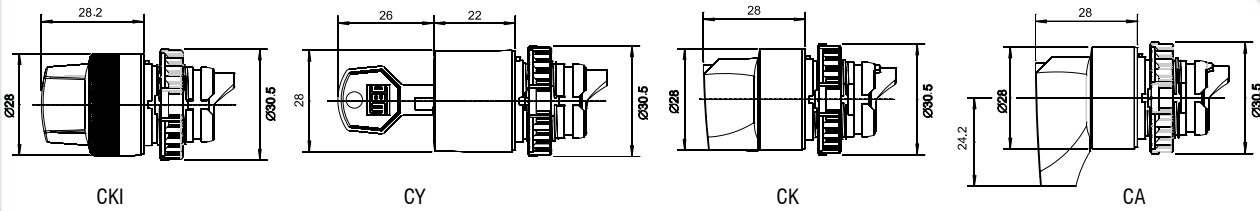

CONTACT BLOCKS

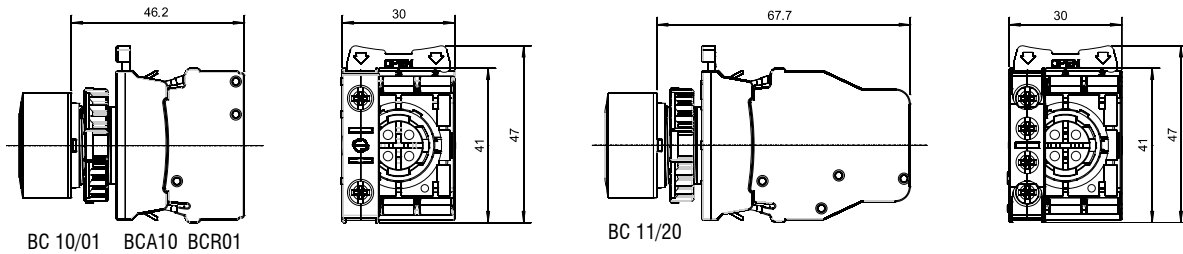

PUSH-ON / PUSH-OFF BLOCK

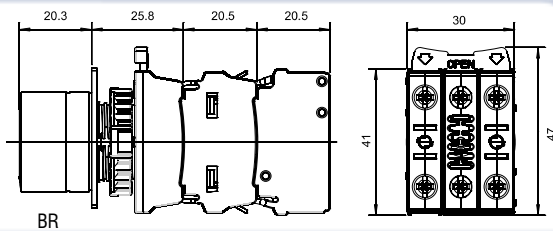

ACCESSORIES

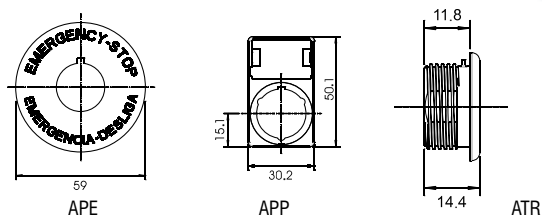

FRACTIONAL HP

GENERAL PURPOSE

NEMA PREMIUM EFFICIENCY

CRUSHER® DUTY

IEC TRU-METRIC™

PUMP MOTORS

DEFINITE PURPOSE

ADD-ON™ MODIFICATIONS

MOTOR TECHNICAL DATA

DRIVES & SOFT STARTERS

CONTROLS